

# MANUAL CWF SERIES

---

WATERFALL - WATERVAL - WASSERFALL - CASCADE

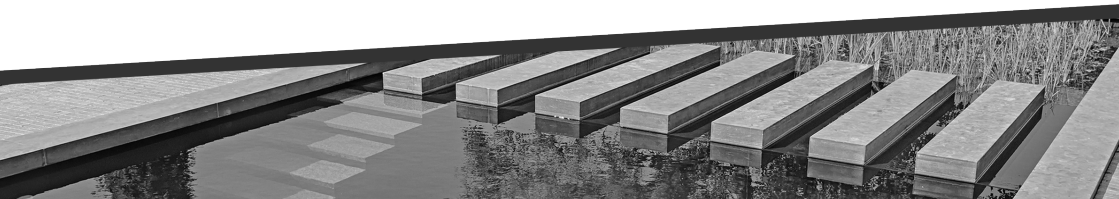

# WF-30T

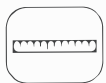
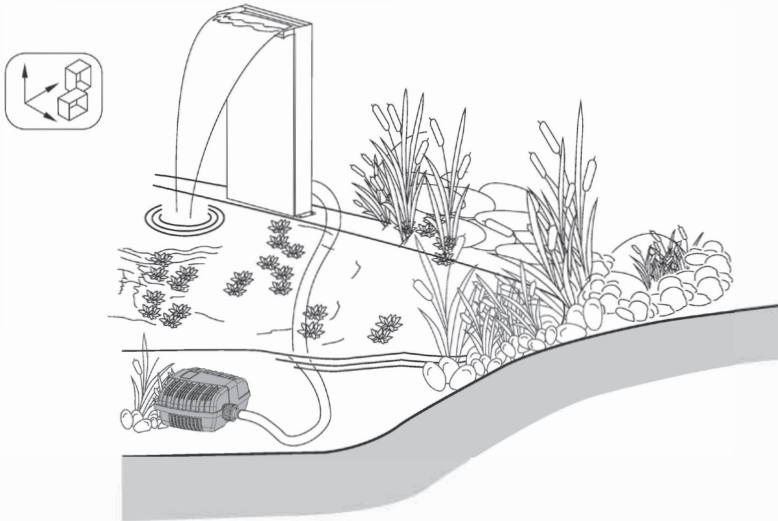
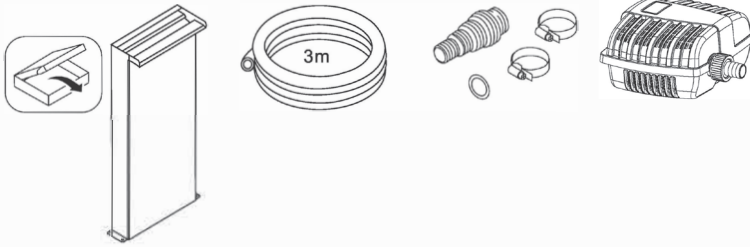

**KG** 5.2kg

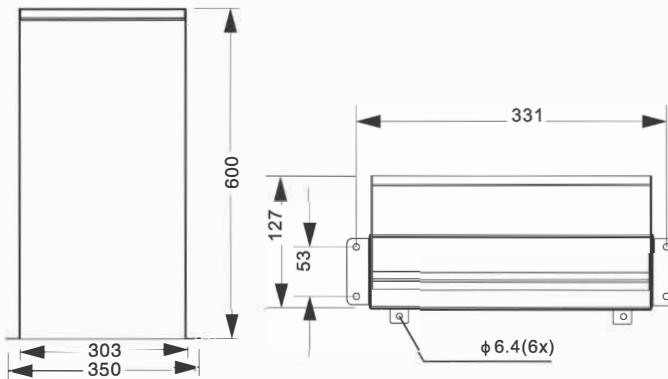

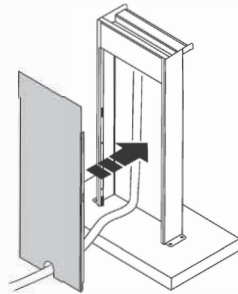
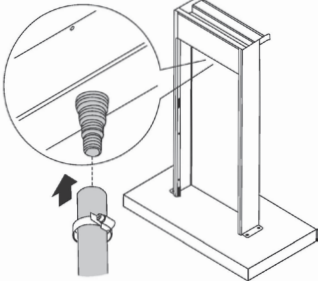
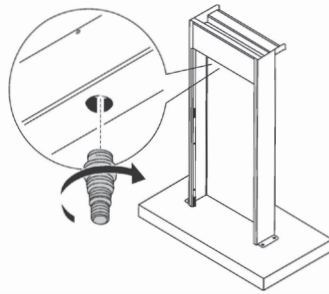
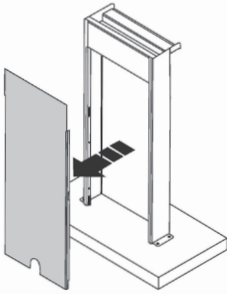
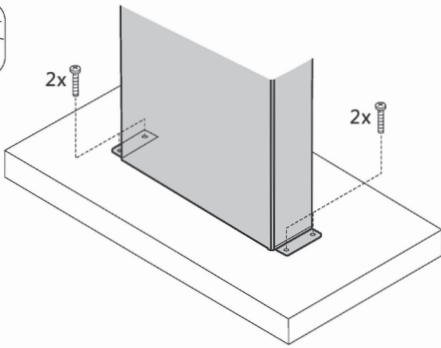

# WF-30/60/90

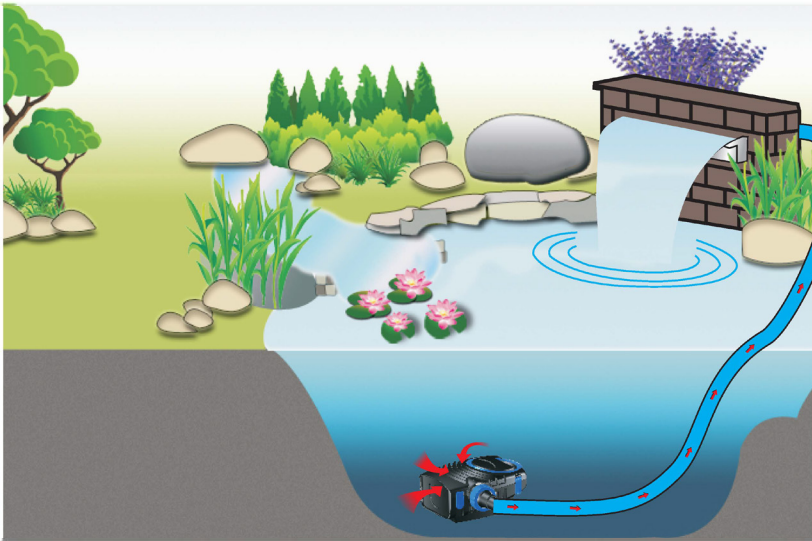
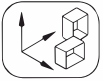
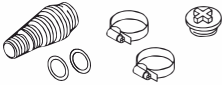
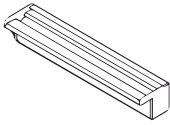



### WF-30

**KG** 2.0kg

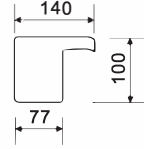
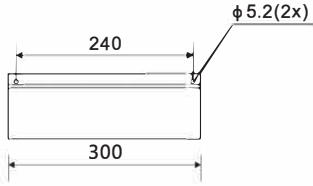

### WF-60



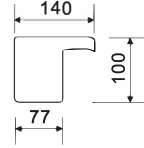
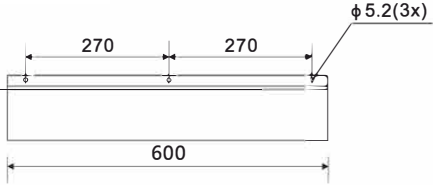

**KG** 4.0kg

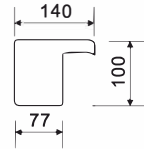
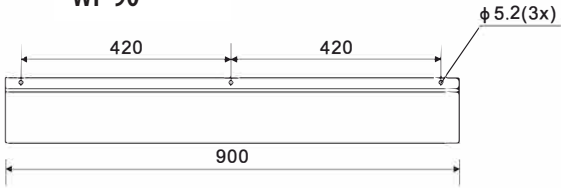

### WF-90

**KG** 6.0kg



	CWF-30		CWF-60		CWF-90	
	 L ≤ 3m φ 1 in	Output (L/h)	 L ≤ 3m φ 1 in	Output (L/h)	 L ≤ 3m φ 1 1/4 in	Output (L/h)
1.00m	3500	4500	8000			
0.80m	3500	4500	8000			
0.60m	2500	3500	6000			
0.40m	2500	3500	6000			
0.20m	2500	3500	4500			

